

MBR series

Application

- Instrument and meter
- Power Amplifier
- Notebook, personal computer
- Precision power supply
- Battery Management system
- Electric Power tool

Features

- Power rating up to 1.5W
- Excellent temperature coefficient characteristics
- Excellent long-term stability
- Non-inductive resistance
- High application temperature range -55 to +170 °C due to special design
- RoHs compliant and halogen free
- AEC-Q200 qualification

Product structure

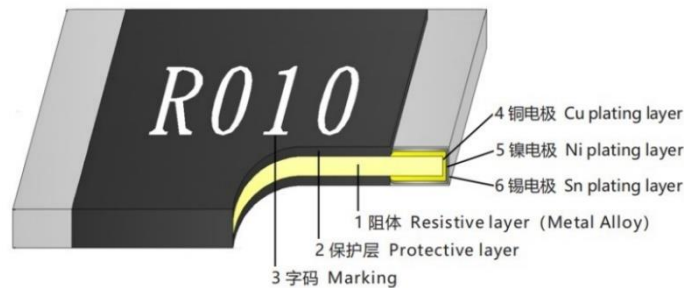

Part Number Explanation

MBR	1206	B5	F	R001	S
Product Type	Size (Inch)	Rated Power	Tolerance	Resistance	Electrode
MBR	1206	A5=0.5W B5=1.5W C5=2.5W D5=3.5W	F=±1% G=±2% J=±5%	R001=1mΩ R010=10mΩ	S=Short electrode L=Long electrode

Standard Electrical Specifications

Type	Part Number	Rated Power /W	TCR ppm/°C	Resistance /mΩ	Marking	Applicable temperature range /°C
1206	MBR1206B5FR001S	1.5	350	1	R001	-55~170
	MBR1206B5FR002S	1.5	350	2	R002	
	MBR1206B5FR003S	1.5	350	3	R003	
	MBR1206B5FR004S	1.5	350	4	R004	
	MBR1206B5FR005S	1.5	50	5	R005	

	MBR1206B5FR006S	1.5	50	6	R006	
	MBR1206B5FR007S	1.5	50	7	R007	
	MBR1206B5FR008S	1.5	50	8	R008	
	MBR1206B5FR009S	1.5	50	9	R009	
	MBR1206B5FR010S	1.5	50	10	R010	
	MBR1206B5FR****S	1.5	50	11-100	R***	

■ Type Dimension

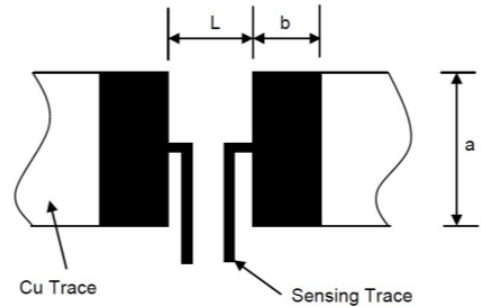
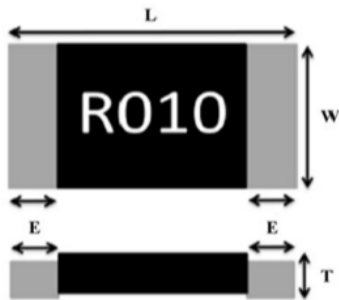

■ Standard Electrical Dimension

Unit: mm

Type	Resistance Range (mΩ)	Electrode	L	W	T	E
1206	1-100	Short	3.2±0.2	1.6±0.2	0.6±0.2	0.5±0.2

■ PCB-layout proposal

Unit: mm

Type	Resistance Range (mΩ)	Electrode	a	b	L
1206	1-100	Short	1.80	1.70	1.60

■ Power Derating Curve

The Operating Temperature Range: -55°C ~+170°C

For resistors operated in ambient temperatures above 70°C, power rating must be derated in accordance with the curve below

■ Rating Current

The following equation may be used to determine the DC (Direct Current) or AC (Alternating Current) (RMS, root mean square value) of normal rated power. However, if the result value exceeds the highest current of regulated standards (paragraph 5), the highest normal rated power is to be used

$$I = \sqrt{P/R}$$

I= Rating current (A)

P= Rating Power (W)

R= Resistance(Ω)

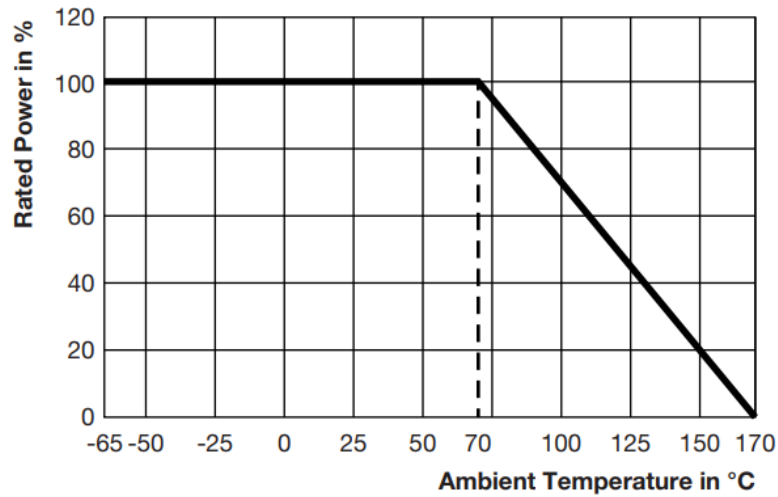

■ Reliability Test and Requirement

Test Item	Test Method	Procedure	Requirements
Temperature Coefficient of Resistance (T.C.R)	MIL-STD-202 Method 304	TCR (ppm/°C) = $\frac{(R2-R1)}{R1(T2-T1)} \times 10^6$ R1: resistance at 25°C (T1) R2: resistance at 125°C (T2)	Refer to Electrical Specification
Short Time Overload	JIS C 5201-1 clause 4.13	The number of rated power are as follows: 5 times of rated power Rating power duration: 5secs	±1.0%
High Temperature Exposure	JIS C 5201-1 clause 4.23.2	170°C±2°C for 1000hrs	±1.0%
Solderability	JIS C 5201-1 clause 4.17	245±5°C for 3 ±0.5secs	The covered area >95%
Low Temp. Storage	JIS C 5201-1 clause 4.23.4	-55°C±2°C for 1000hrs	±1.0%
Soldering Heat	MIL-STD-202 Method 210	260±5°C for 10±1 seconds.	±1.0%
Temperature Cycling	JIS C 5201-1 clause 4.19	-55°C to +155°C, 100 cycles	±1.0%
Load Life	MIL-STD-202 Method 108	70°C± 2°C, 1000 hours, at rated power 1.5 hours "ON", 0.5 hours "OFF"	±1.0%
Temperature Humidity Bias Test	MIL-STD-202 Method 103	+85°C, 85% RH, 10%bias, 1000hours	±0.5%
Mechanical shock	MIL-STD-202 Method 213	100 g'sec ,6 msec, 5puls	±0.5%

Vibration	MIL-STD-202 Method 204	Frequency varied 10 Hz to 2000 Hz in 1 min, 3 directions, 12 h	±1.0%
Moisture resistance	MIL-STD-202 Method 106	MIL-STD-202,method 106, No power, 7a and 7b not required	±1.0%

■ Marking Format

- All type products marking are 4 digits.
 "R" designates the decimal location in ohms
 e.g. 1mΩ the product marking is R001.
 5mΩ the product marking is R005 .
 10mΩ the product marking is R010.
 "M" designates the decimal location in milli-ohms
 e.g. 0.5mΩ the product marking is 0M50.
 1.5mΩ the product marking is 1M50.
 2.5mΩ the product marking is 2M50.
- The criteria to distinguishing the mark on the surface of products are that characters can be identified.

■ Recommended IR Reflow Profile

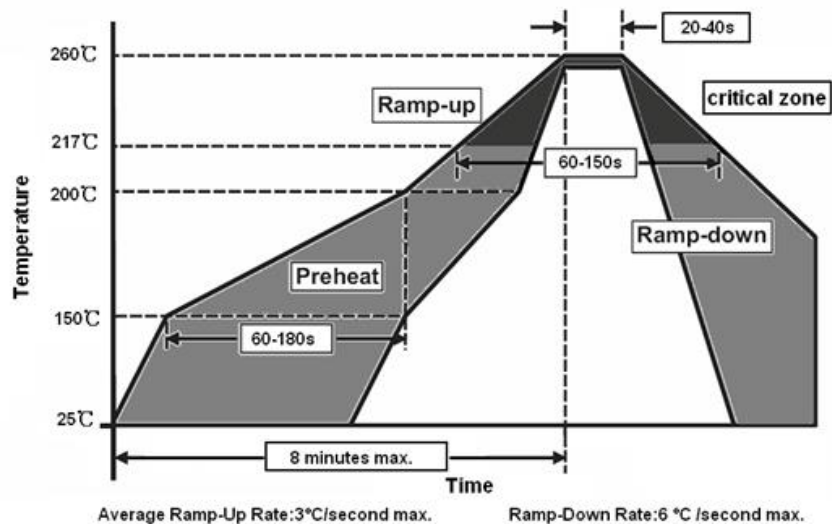

■ Quantity of Package

Type	Resistance Value /mΩ	Electrode	Quantity /Pcs
1206	1-100	Short	5000

■ Reel Dimensions

Unit: mm

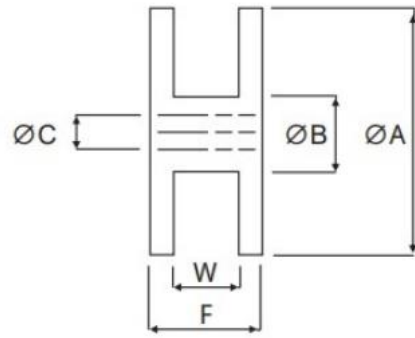

TYPE	ΦA	ΦB	ΦC	F	W
1206	178.0±2.0	60.0±1.0	13.5±0.5	11.4±0.1	9.0±0.3

Carrier Dimensions

Unit: mm

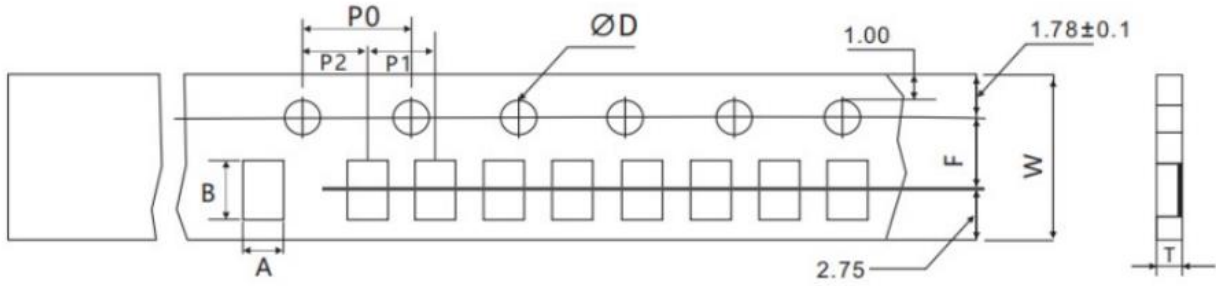

MBR Series (1206)							
A	2.0±0.15	B	3.6±0.20	ΦD	1.5+0.1/0.0	F	3.50±0.05
P0	4.00±0.10	P1	4.00±0.10	P ₀	2.00±0.05	W	8.00±0.10
T	0.84±0.10						

Peeling Strength of Top Cover Tape

Peeling Strength: 0.1-1.0N at a peel-off speed of 300 mm/min.

Storage Requirement

Temperature: 5~35°C, Humidity: 45%RH~75%RH

Sealed plastic bags with desiccant shall be used to reduce the oxidation of the termination and shall only be opened prior to use.

The products shall not be stored in areas where harmful gases containing sulfur or chlorine are present.

When the product is finally discarded, it can be treated as general electronic waste, and raw material compositions of CSR can be referred to MSDS.